

- > Port size: 1/2" ... 1" (ISO G/PTF)
- > Coalescing element provides high efficiency oil and particle removal
- > Standard visual service indicator turns from green to red when the filter element needs to be replaced
- > Optional male threaded drain adaptor available for connection to pilot or solenoid operated drain valve (install a pre-filter with a 5 µm filter element upstream of the filters for optimum coalescing element life)



Technical features

Medium:

Compressed air only

Maximum operating pressure:

17 bar (246 psi)

Particle removal:

To 0,01 µm

Maximum remaining oil content in outlet air:

0,01 mg/m³ max at +21°C (+70°F)

Flow:

See table below

Port sizes:

1/2", 3/4" or 1"

Drain:

Manual or automatic

Automatic drain conditions:

Pressure to close drain:

> 0,3 bar (4.3 psi)

Pressure to open drain:

< 0,2 bar (2.9 psi)

Minimum air flow to close drain:

0,6 dm³/s (1.3 scfm)

Service life indicator:

Standard

Bowl size:

0,5 litre (17 fluid oz standard);

1 litre (34 fluid oz optional)

Ambient/Media temperature:

-20° ... +65°C (-4° ... +122°F)

Air supply must be dry enough to avoid ice formation at temperatures below +2°C (+35°F).

Materials:

Body, yoke and bowl: Aluminium

Liquid level indicator: Pyrex

Element: synthetic fibre and PU foam

Elastomers: NBR

Service life indicator:

Body: Transparent PA

Internal parts: Acetal

Spring: Stainless steel

Elastomers: NBR

Technical data - standard models

Symbol	Port size	Size	Drain	Flow *1) (dm ³ /s)	Weight (kg)	Model
	1/2"	—	Manual	35	2,38	F68C-4GD-MR0
	3/4"	Basic	Manual	35	2,72	F68H-6GD-MU0
	1"	—	Manual	60	2,66	F68H-8GD-MU0
	Without yoke	—	Manual	—	—	F68H-NND-MU0
	1/2"	—	Automatic	35	2,38	F68C-4GD-AR0
	3/4"	Basic	Automatic	35	2,72	F68H-6GD-AU0
	1"	—	Automatic	60	2,66	F68H-8GD-AU0
	Without yoke	—	Automatic	—	—	F68H-NND-A00

* Typical flow with inlet pressure 6,3 bar (90 psi) set pressure.

Option selector

Bowl/Element	Substitute
High flow	H
Standard	C
Port size	Substitute
1/2"	4*1)
3/4"	6
1"	8
Without yoke	N
Thread	Substitute
NPT	A
ISO G parallel (standard)	G
Without yoke (standard)	N

F68★-★-★-★-★0

Bowl	Substitute
0,5 l with liquid level indicator *1)	R
1 l with liquid level indicator	U
Drain	Substitute
Automatic	A
Manual, spindle type	M
Service life indicator	Substitute
With mechanical service indicator (standard)	D
With electrical service life indicator	E
Without indicator	N

*1) Only available with the F68C standard filter.

Typical performance characteristics

Inlet pressure (bar)	Maximum flow dm ³ /s* 1/2" and 3/4"	1"
1	14	24
3	24	41
5	31	53
6,3	35	60
7	36,7	63
9	42	72

* Maximum flow to maintain stated oil removal performance

Flow characteristics

Port size: 1/2"
Dry element

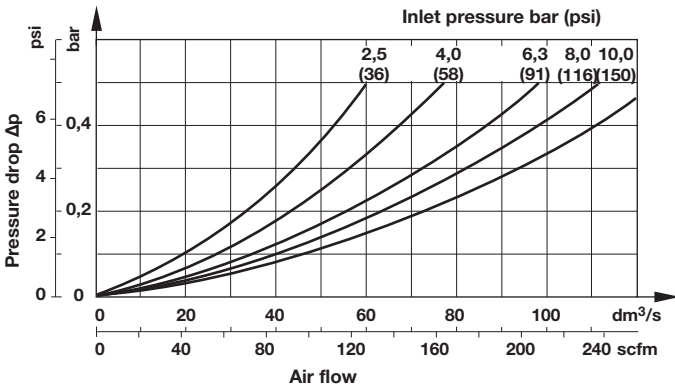

Port size: 1"
Dry element

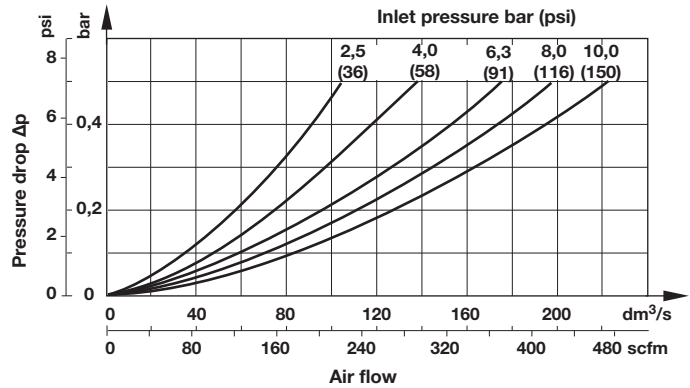

Accessories

	Single yoke	Double yoke	End connector kit	Single yoke non threads	3/2 Shut-off valve Threaded inlet only	Threaded outlet only	Bracket mounting
Thread							
G1/2	Y68A-4GN-N1N	Y68A-4GN-N2N			T68H-4GB-B2N	T68H-4GC-B2N	18-001-979
G3/4	Y68A-6GN-N1N	Y68A-6GN-N2N	5524-55	74785-98	T68H-6GB-B2N	T68H-6GC-B2N	18-001-979
G1	Y68A-8GN-N1N	Y68A-8GN-N2N	5524-52		T68H-8GB-B2N	T68H-8GC-B2N	18-001-979
1/2 PTF	Y68A-4AN-N1N	Y68A-4AN-N2N			T68H-4AB-B2N	T68H4AC-B2N	18-001-979
3/4 PTF	Y68A-6AN-N1N	Y68A-6AN-N2N	5524-53		T68H-6AB-B2N	T68H-6AC-B2N	18-001-979
1 PTF	Y68A-8AN-N1N	Y68A-8AN-N2N	5524-50		T68H-8AB-B2N	T68H-8AC-B2N	18-001-979

Nut	Porting block
5520-89	18-026-986 (G1/4 & G1/2)
	18-026-983 (1/4 & 1/2 NPT)

Service kit

Service kit, Automatic drain
F68C-KITA0C
F68H-KITA0C

Dimensions

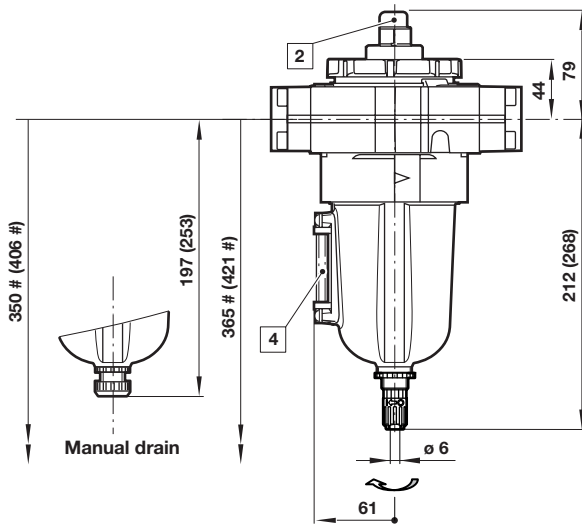
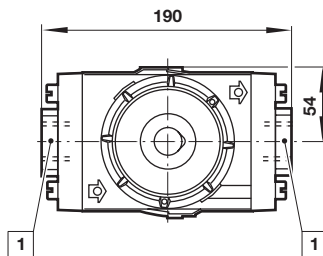
 Dimensions in mm
 Projection/First angle

Automatic drain

Minimum clearance required to remove bowl

() values for 1 litre bowl

1 Main ports 1/2", 3/4" or 1"

2 Service life indicator

4 Sight glass

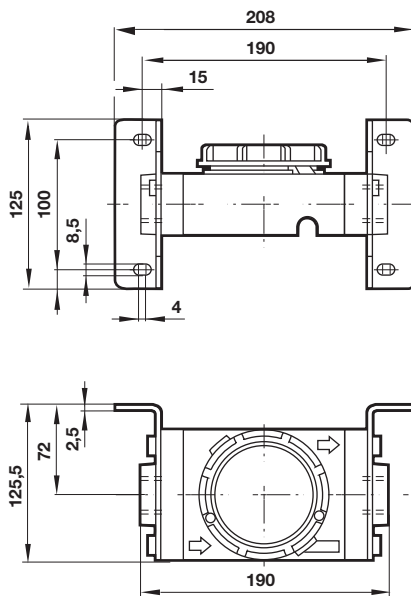
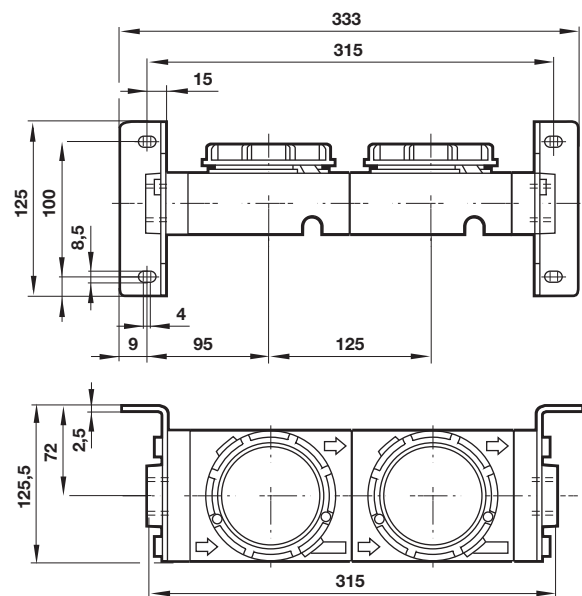
Single yoke with bracket

Double yoke with bracket

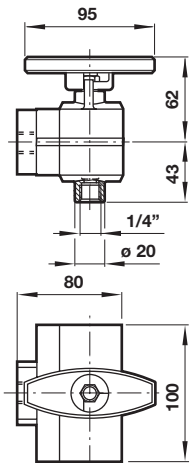
3/2 Shut-off valve

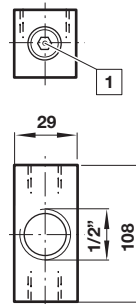

Porting block

Dimensions in mm
Projection/First angle



1 Two additional plugged G1/4 ports

Warning

These products are intended for use in industrial compressed air systems only. Do not use these products where pressures and temperatures can exceed those listed under

»**Technical features/data**«.

Before using these products with fluids other than those specified, for non-industrial applications, life-support systems or other applications not within published specifications, consult IMI Precision Engineering, Norgren GmbH. Through misuse, age, or malfunction, components used in fluid power systems can fail in various modes.

The system designer is warned to consider the failure modes of all component parts used in fluid power systems and to provide adequate safeguards to prevent personal injury or damage to equipment in the event of such failure.

System designers must provide a warning to end users in the system instructional manual if protection against a failure mode cannot be adequately provided.

System designers and end users are cautioned to review specific warnings found in instruction sheets packed and shipped with these products.