

Excelon® modular system

V72G, V74G Pressure Relief Valves

Excelon® design allows in-line installation or modular installation with other Excelon® products

Push to lock adjusting knob with tamper resistant accessory

Helps protect air operated equipment from over pressure by retarding excessive pressure build up

Technical data

Fluid:

Compressed air, neutral gases

NOTE: Contact Norgren for use with other media.

Maximum pressure:

300 psig (20 bar)

Operating Temperature*:

(72) -30° to 150°F (-34° to 65°C)

(74) -30° to 175°F (-34° to 80°C)

* Air supply must be dry enough to avoid ice formation at temperatures below 35°F (2°C).

V72

Gauge Ports:

1/8" PTF with PTF main ports

1/8" ISO Rc with ISO G main ports

Exhaust Port:

1/4" PTF with PTF main ports

1/4" ISO Rc with ISO G main ports

Materials

V72G

Body: zinc body

Bonnet: acetal

Elastomers: neoprene

Bottom plug: acetal

V74G

Body & bonnet: aluminum

Valve: aluminum and nitrile

Elastomers: neoprene

Bottom plug: acetal



V72G



V74G

Ordering Information

Models listed include PTF threads, knob adjustment, and a 5 to 150 psig (0.3 to 10 bar) relief pressure adjustment range, with gauge.*

Size	Model	Service kit
1/4	V72G 2AK NMG	4209 03
3/8	V74G 3AK NMG	4384 700
1/2	V74G 4AK NMG	4384 700
3/4	V74G 6AK NMG	4384 700

Note: for Excelon 73 combinations use V74G.

Options selector

Series	Substitute				
72	2	← V7★G ★★ ★★ N★★	→ Gauge		Substitute
74	4			With	G
				Without	N
Port size	Substitute		→ Relief pressure adjustment range*		Substitute
1/4" (72)	2	5 to 60 psig (0.3 to 4 bar)		F	
3/8" (72, 74)	3	5 to 150 psig (0.3 to 10 bar)		M	
1/2" (74)	4	10 to 250 psig (0.7 to 17 bar)		S	
3/4" (74)	6				
Threads	Substitute		→ Adjustment		Substitute
PTF	A	Knob		K	
ISO G parallel	G	T-bar		T	

* Relief valve can be adjusted to pressures in excess of, and less than, those specified. Do not use these units to control pressures outside of the specified ranges.

** Units with 250 psig relief pressure range are available only with the T-bar adjustment; therefore substitute T at the 7th position and S at the 9th position.

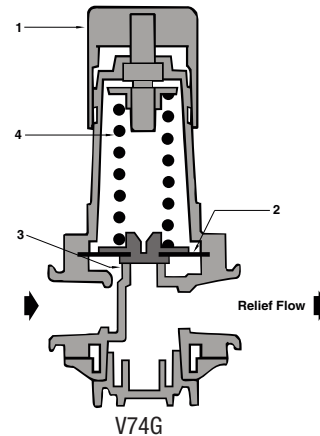
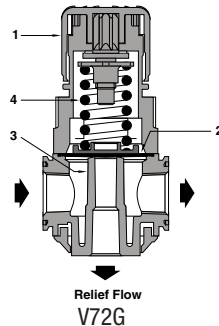
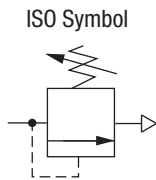

Excelon® modular system

V72G, V74G Pressure Relief Valves

Dimensions in inches.

Accessories

Wall mounting bracket*



Neck mounting bracket



Gauge 0 ... 160 psig



Plastic panel nut



Tamper resistant cover and seal wire



Pipe adapters (quantity of 1 (NPT))

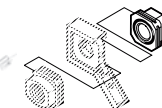

Quikclamp®



Quikclamp® and wall bracket



Service kit Diaphragm and seal

V72G	4224-50	74316-50	18-013-212	4248-89	4255-51	4215-02 (1/4) 4215-03 (3/8)	4214-51	4214-52	4209-03
V74G	4324-50	4368-51	18-013-209	4348-89	4355-51	4315-02 (3/8) 4315-03 (1/2) 4315-04 (3/4)	4314-51	4314-52	4384-700

* Bracket kit does not include wall mounting screws.

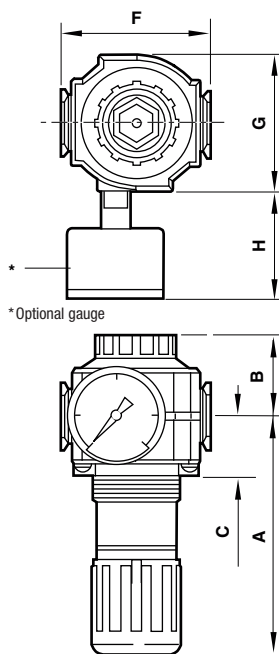

Neck mounting bracket

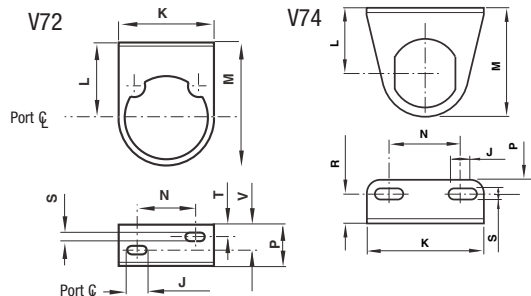

Series	J	K	L	M	N	P	R	S	T	V
72	0.31	1.93	1.50	2.50	1.18	0.94	-	0.17	0.31	0.59
74	0.94	3.50	2.05	3.39	2.20	1.38	0.91	0.28	-	-

Mounting bracket

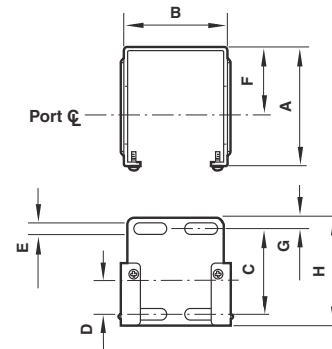

Series	A	B	C	D	E	F	G	H
72	2.36	1.65	1.54	0.73	0.16	1.50	0.24	2.01
74	3.11	2.72	1.97	0.79	0.20	2.01	0.24	2.40

	A	B	C	F	G	H	Panel Ø	Panel depth
72	2.87	0.98	1.02	1.97	1.89	1.38	1.57	0 ... 0.2
74	5.00	1.69	1.22	3.15	2.91	2.20	2.05	0.08 ... 0.2

Typical Performance Characteristics

V72 RELIEF CHARACTERISTICS

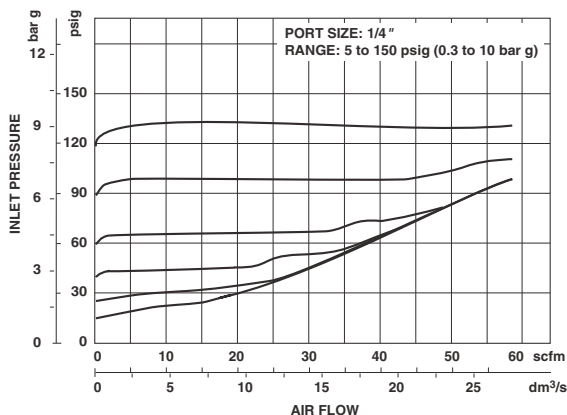

V74 RELIEF CHARACTERISTICS

